



Key Benefits

- ▶ 19" LED, 1280 x 1024 native resolution
- ▶ 16.7 M colors / 250 cd/m² brightness
- ▶ DVI-D + VGA video input
- ▶ Video decoding capability up to 1080p (option)
- ▶ Rugged structure ensures high mobility
- ▶ IP65 front protection (NAP series)
- ▶ 1000 cd/m² sunlight readable panel available
- ▶ Professional-use durability & around-the-clock operation
- ▶ 2-year standard warranty (upgradable up to 5 years)

Applications

- Broadcasting / Advertising
- Traffic control / Command center
- Directory / Ticket kiosk
- Surveillance system
- Vehicle mount display
- Bathroom TV

UltraView 19 series LED monitor supports 1280 x 1024 resolution. 16.7 million colors achieve high picture quality. Improved energy efficiency and fan-less architecture provides professional-use durability and around-the-clock operation.

It is more than just a standalone monitor. UltraView has a variety of embedded modules including HDMI Decoder, HDMI Extender, HDMI Quad display Extender, Multi-Monitor OSD Controller and SDI Input. The embedded modules give you the ability of video remote management and transmission for multiple monitors over network.

As a versatile 1280 x 1024 monitor, 19 is meticulously designed to meet professional and environmental demands including Sunlight readable brightness, IP54 Front protection, Multi-touch, Anti-reflective/Vandal proof glass, DC power input, Brightness dimming and Mounting kit for Panel-mount, VESA-mount, Universal-mount and Desktop stand.

With over 22 years' production experience, the structure is well-engineered and manufactured by our own CNC facilities and team of experts to ensure its ruggedness, mobility and quality, as well as being suitable for harsh environment applications. The structure can be customized if required to facilitate monitor installation. Our knowledgeable engineers are able to provide frame customization for specific dimensions, color, metal treatment, screen printing, bezel and mounting.

Options

Video Management & Transmission over Network

- Embedded HDMI Decoder Module 1080p over IP
- Embedded HDMI Extender Module 1080p over network
- Embedded HDMI Quad Display Module 1080p over network
- Embedded HDMI Quad Display Extension Module
- Embedded Multi Monitor OSD Control Module over serial
- Embedded 3G / HD / SD-SDI Input Module
- Embedded Brightness Dimming Module
- HDMI 1.2 / S-Video + BNC

Bezel & Frame Customization

- Dimension
- Color & Treatment
- Screen Printing
- Stainless Steel Bezel

Touchscreen & Glass Protection

- Projected Capacitive 10-point Touch
- 5-Wire Resistive 1-point Touch
- Capacitive 1-point Touch
- Anti-reflective Glass
- Vandal Proof Glass

DC Power

- 12V / 24V / 48V / 125VDC (50 Watt)

Mounting

- VESA mount, 100 x 100mm (bundled)
- Universal mount (bundled)
- Desktop stand (option)
- Panel mount (bundled)

250 cd/m² Brightness

1000 cd/m² Sunlight Readable Brightness

6mm aluminum front bezel

6mm aluminum front bezel



AP-19



HAP-19

6mm aluminum front bezel
NEMA 4 / IP65 front protection



6mm aluminum front bezel
NEMA 4 / IP65 front protection



NAP-19



NHAP-19

Aluminum front cover

Aluminum front cover

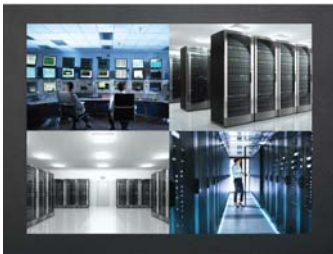

DP-19



HDP-19

Universal open frame

Universal open frame



OP-19



HOP-19

MP-19

Industrial Display Kit

- 4:3 19" LED
- LCD controller
- AC power

Options — Video Management & Transmission over Network

Embedded HDMI Decoder Module 1080p over IP

- Decodes RTSP, RTMP, UDP, HTTP, HLS protocols
- Supports video resolutions up to 1080p / 60Hz
- Unicast and multicast support
- Operates on standard 1000Mb Ethernet networks
- Built-in Web UI for configuration and control
- Excellent image quality with very low delay

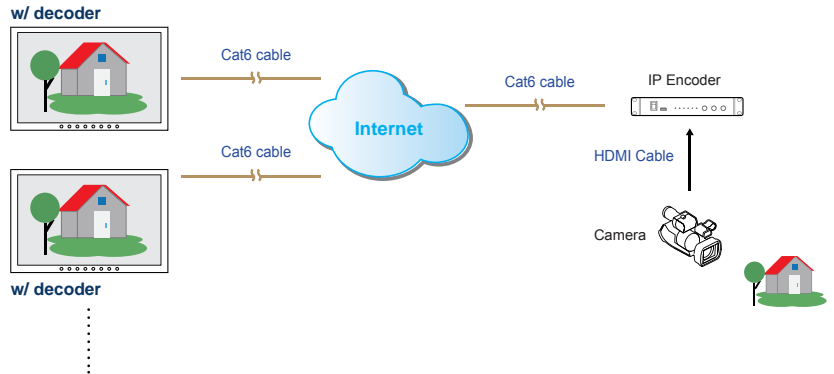

Part no.

Embedded HDMI Decoder Module : **UV-DE100F**
 Standalone HDMI Encoder : **UV-EN100F**

Embedded HDMI Receiver Module 1080p

- Extends the HDMI signal over a single Cat5/6 cable
- Supports video resolutions up to 1080p / 60Hz
- One to one just via Cat5/6 cable
- One to multi via network hub and Cat5/6 cable
- 100m maximum Cat5/6 cable distance
- Supports bi-directional IR communication
- High Speed HDMI 1.3 and HDCP 1.1 compliant
- No software or drivers required

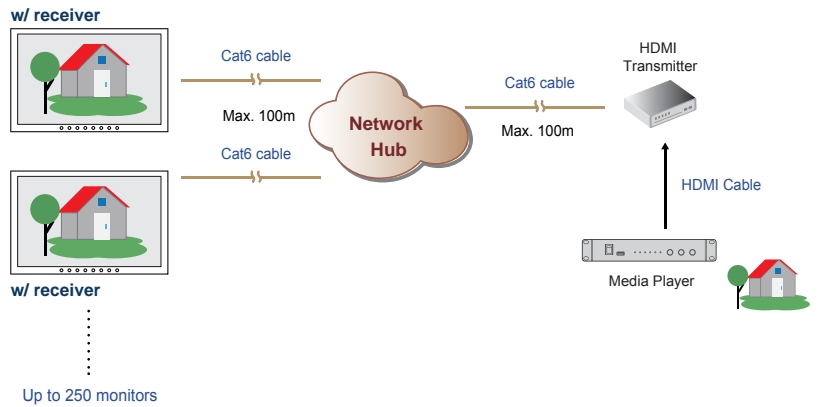

Part no.

Embedded HDMI Receiver Module : **UV-R100F**
 Standalone HDMI Transmitter : **UV-T100F**

Embedded HDMI Quad Display Module 1080p

- Allows 4 x HDMI inputs to be monitored simultaneously
- Quad split, panel left and full screen monitoring modes
- High speed HDMI 1.3a and HDCP 1.2 compliant
- Supports video resolutions up to 1080p / 60Hz
- Supports Scaler Up and Down function
- Control via local front panel and IR remote

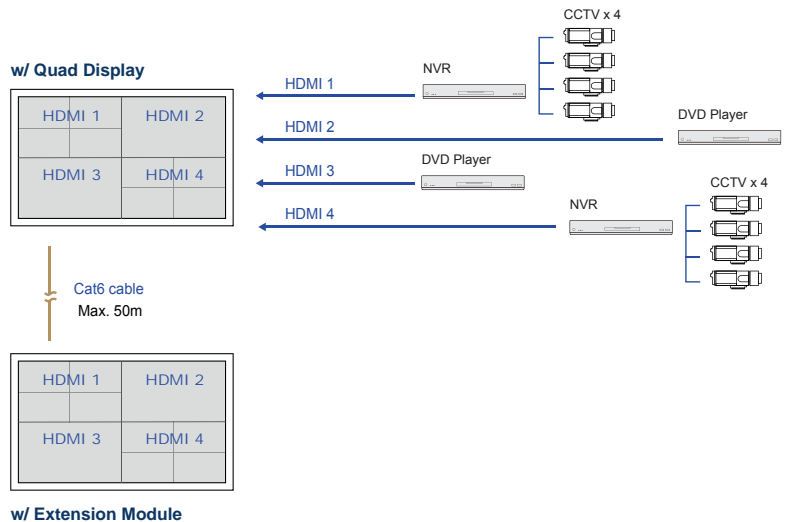

Part no.

Embedded HDMI Quad Display Module : **QD-1080**
 Embedded Quad Display Extension Module : **QD-E1080**

Options — Video Management & Transmission over Network

Embedded Multi Monitor OSD Control Module over serial

- Remote control the monitor OSD via RS-232C serial interface
- Daisy chain up to 64 monitors via Cat5/6 cable
- Individual ID for individual monitor OSD settings
- Power ON or OFF monitor
- Adjust brightness & audio
- Switch video sources

Up to 64 monitors
Up to 1,000m distance

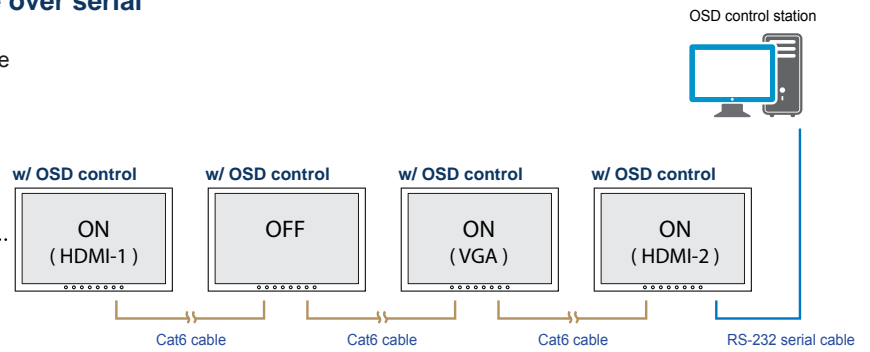

Part no.

Embedded Multi Monitor OSD Control Module : **MCS**

Embedded 3G / HD / SD-SDI Input Module

- Intelligent SDI monitoring with broadcast quality scopes
- Supports multi-rate 3G / HD / SD-SDI format
- Provides input to output loop-through capability
- Auto format sensing & selection

Part no.

Embedded 3G / HD / SD-SDI Input Module : **SDI**

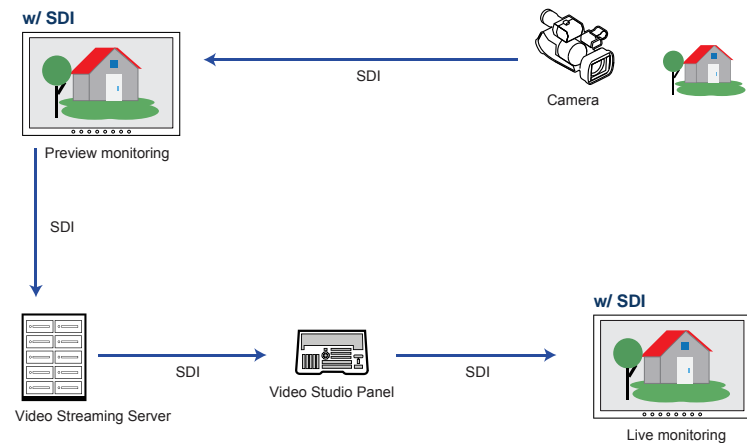

Embedded Auto Brightness Dimming Module

- Brightness changes according to its ambient brightness
- Its brightness change causes 10% increase or decrease

Part no.

Embedded Brightness Auto Dimming Module : **DA-01**

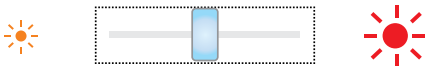

Embedded Manual Brightness Dimming Knob

- Easy-to-use IP54 dimming knob on the front panel
- One click causes 2% brightness increase or decrease
- Brightness adjustment from 0% to 100%

Part no.

Brightness Dimming Knob : **DS-01**

Option — e-Resistive 1-point Touch

	TRB e-Resistive
Technology	5-Wire Resistive
Touch Point	Single
Input Type	Finger or Stylus
Resolution	2048 x 2048
Response Speed	15 ms
Activation Force	≤ 50 g
Surface Hardness	3H
Light Transmission	80% ± 3%
Haze	8% ± 3%
Durability	10 million touches
Top Layer	ITO Film
Bottom Layer	ITO Glass
Thickness	3.2 ± 0.2 mm
Connector	USB Type A
Compatibility	Windows 7 / XP / Linux / Mac

Part no. : 19TRB

** Dimension will be changed if multi-touch required

Option — e-Capacitive 1-point Touch

	TCB e-Capacitive
Technology	Capacitive
Touch Point	Single
Input Type	Finger
Resolution	2048 x 2048
Response Speed	20 ms
Activation Force	≤ 50 g
Surface Hardness	9H
Light Transmission	92% ± 2%
Haze	7%
Durability	300 million touches
Top / Bottom Layer	Glass
Thickness	2.8 mm ± 10%
Connector	USB Type A
Compatibility	Windows 7 / XP / Linux / Mac

Part no. : 19TCB

** Dimension will be changed if multi-touch required

Option — Projected Capacitive 10-point Touch

	TPC-10 Multi-touch
Technology	Projected Capacitive
Touch Point	10 point touch standard (special requirement available)
Input Type	Finger or Capacitive Stylus
Resolution	2048 x 2048
Touch Point Accuracy	± 10 mm offset
Response Speed	Max. 20 ms
Activation Force	≤ 10 g
Surface Hardness	7H
Light Transmission	≥ 88%
Haze	≤ 2%
Durability	> 100 million touches
Top Layer	1.8 mm Tempered Glass
Bottom Layer	Film
Thickness	2.2 mm
Connector	USB Type A
Compatibility	Windows 7

Part no. : 19-TPC10

** Dimension will be changed if multi-touch required

Options — DC Power

		12V	24V	48V	125V
Input rating	Input voltage	12-Volt	24-Volt	48-Volt	110-Volt
	Input range	9 ~ 18V	18 ~ 36V	36 ~ 75V	66 ~ 160V
Input current	No load	50 mA	50 mA	50 mA	35 mA
	Full load	4950 mA	2450 mA	1220 mA	749 mA
Output rating	Output voltage	12-Volt	12-Volt	12-Volt	12-Volt
	Output current	4.16A	4.16A	4.16A	6.25A
Efficiency		84%	85%	85%	91%

Part no. : 12VDC
24VDC
48VDC
125VDC

Product Specifications

LCD Panel	Standard	Sunlight Readable
Brightness (cd/m ²)	250	1000 
Panel size (diagonal)	19-inch TFT color LCD	
Native resolution	1280 x 1024	
Contrast ratio (typ.)	1000 : 1	
Colors	16.7 M	
Response time (ms)	5	
Viewing angle (L/R/U/D)	85/85/80/80	
Dot pitch (mm)	0.294	
Display area (mm)	376.32H x 301.06V	
Surface treatment	Haze 25%, Hard-coating	
Surface hardness	3H	
Backlight type	LED	
MTBF (hrs)	30,000	

Video	
VGA	Analog 0.7Vp-p
DVI	DVI-D single link

Video Option	
HDMI	HDMI 1.2 / HDCP 1.1
Composite (BNC)	NTSC & PAL
S-Video (4-pin)	NTSC & PAL

Audio Option	
Audio input :	
Connector	3.5mm stereo jack
Impedance / Power level	30kΩ / 750mV
Audio output :	
Connector	3.5mm stereo jack
Resistance / Power level	30kΩ / 2.8V
Speaker :	
Dual stereo speaker	2W x 2

*When the audio output is connected, speaker output is OFF

Power		
Input	Auto-sensing 100 to 240VAC, 50 / 60Hz	
Consumption :		
Screen on	Max. 25W	Max. 35W
Power saving mode	Max. 4W	Max. 4W
Power button on	Max. 1W	Max. 1W

Environment	
Operating temp.	0 to 55°C degree
Storage temp.	-20 to 60°C degree
Operating humidity	20~90%, non-condensing
Storage humidity	5 ~90%, non-condensing
Operating altitude	16,000 ft
Non-operating altitude	40,000 ft
Shock	10G acceleration (11ms duration)
Vibration	10~300Hz 0.5G RMS random vibration

Design	AP-19	NAP-19	DP-19	OP-19
Protection	6mm front bezel	NEMA 4 / IP65	front cover	open frame
Front panel	Black, RAL 9005			-
Rear casing	Black, RAL 9005			

Mounting	AP-19 / NAP-19	DP-19	OP-19
VESA mount	100 x 100 mm	100 x 100 mm	100 x 100 mm
Universal mount	-	-	bundled
Desktop stand	option	option	-
Panel mount	bundled	-	-

Physical	AP-19 / NAP-19	DP-19	OP-19
Product (W x D x H) :			
mm	476.5 x 63.6 x 384.1	445.5 x 58.9 x 353.1	473.5 x 57.6 x 381.1
inch	18.8 x 2.5 x 15.1	17.5 x 2.3 x 13.9	18.6 x 2.3 x 15
Packing (W x D x H) :			
mm	651 x 124 x 597	651 x 124 x 597	651 x 124 x 597
inch	25.6 x 4.9 x 23.5	25.6 x 4.9 x 23.5	25.6 x 4.9 x 23.5
Net weight	7.7 kg / 16.9 lb	7.7 kg / 16.9 lb	6.7 kg / 14.7 lb
Gross weight	10.5 kg / 23.1 lb	10.5 kg / 23.1 lb	9.5 kg / 20.9 lb
Chassis color	dark		
Chassis materials	Aluminum		

Compliance	
EMC	FCC & CE certified
Safety	CE / LVD certified
Environment	RoHS2 & REACH compliant

Applicable Format			
DVI-D / VGA Input	PC signal	1280 x 1024 x 60 / 75Hz	
		1280 x 960 x 60Hz	
		1280 x 768 x 60 / 75Hz	
		1152 x 864 x 75Hz	
		1024 x 768 x 60 / 70 / 75Hz	
		848 x 480 x 60Hz	
		800 x 600 x 60 / 72 / 75Hz	
		720 x 400 x 70Hz	
		640 x 480 x 60 / 72 / 75Hz	
		640 x 400 x 70Hz	
640 x 350 x 70Hz			
HDMI input	Audio signal	2ch Linear PCM	
	PC signal	Same as VGA	
		HDMI 1.2	1280 x 720 x 50 / 60Hz (720p) 720 x 480 x 50 / 60Hz (576p / 480p)
		Audio signal	2ch Linear PCM

Diagrams (mm)

Front View

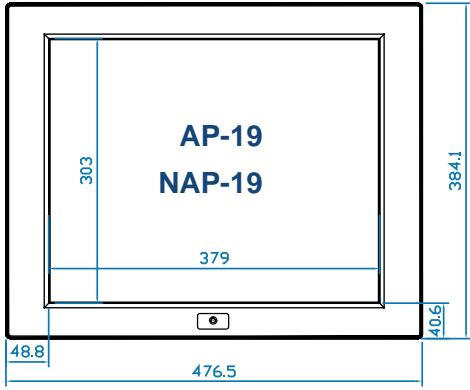

Side View

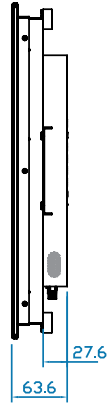

Rear View

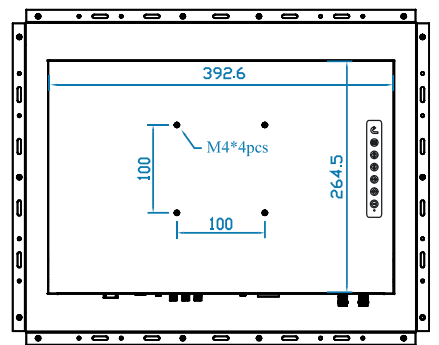
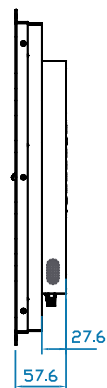
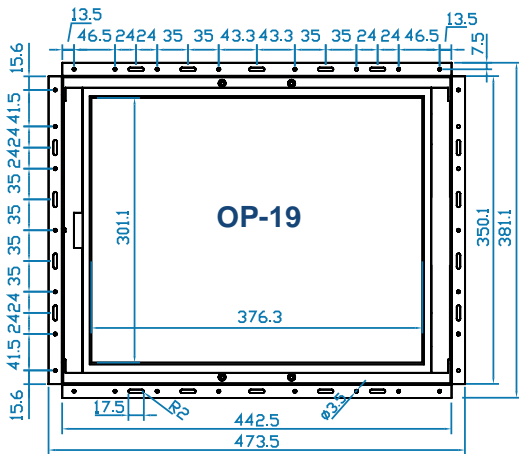
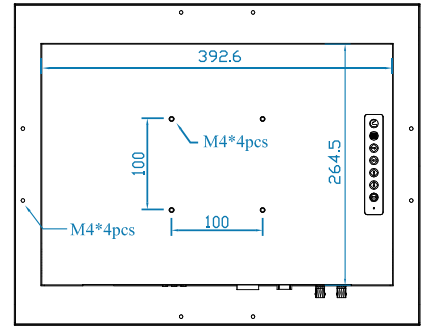
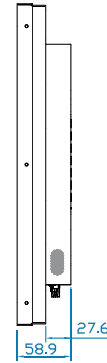
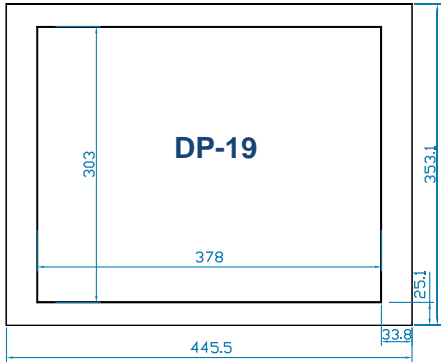
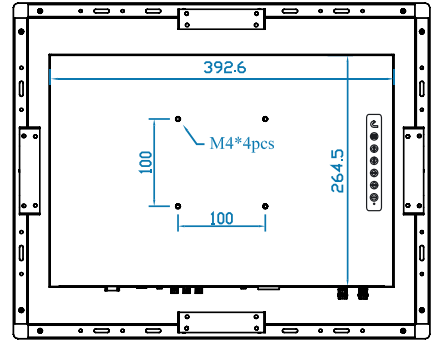

UltraView Family

UltraView series covers a full range of professional LCD display sizes from 6.5" to 65". Please select from the below the most suitable model for your application.

Sales Inquiry

inquiry@austin-hughes.com

Technical Support

support@austin-hughes.com

16 : 9 (4K / 1080p)

- K65"
- K55"
- K43"
- K32"
- K28"
- K23"
- K17"
- K15"

16 : 9 (1080p)

- F21"
- F17"
- F15"

16 : 10

- X24" (1920 x 1200)
- X17" (1920 x 1200)
- W19" (1440 x 900)

4 : 3

- 20" (1600 x 1200)
- 19" (1280 x 1024)
- 17" (1280 x 1024)
- 15" (1024 x 768)
- 12" (800 x 600)
- 10" (800 x 600)
- 8" (800 x 600)
- 6" (640 x 480)

Sunlight Readable

16 : 9 (4K / 1080p)

- K65"
- K55"
- K43"
- K32"

16 : 9 (1080p)

- F21"
- F17"

16 : 10

- W19" (1440 x 900)

4 : 3

- 19" (1280 x 1024)
- 17" (1280 x 1024)

Austin Hughes has an extensive distribution network, including EMEA, the Americas & APAC.

Contact your nearest sales office for details of local presentation.

Sales Inquiry

inquiry@austin-hughes.com

Technical Support

support@austin-hughes.com

Distributed by:

Distributor by country on application