

User Manual - KVM Rear Kit Version for RK-1 Rack Keyboard Drawer

Combo DB-15 **IP** KVM

-IP802
-IP1602

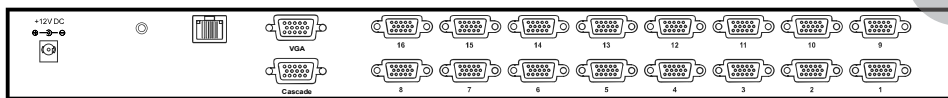

Combo DB-15 2-console KVM

-802
-1602

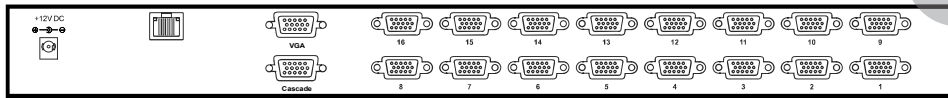

Combo DB-15 KVM

-S801
-S1601

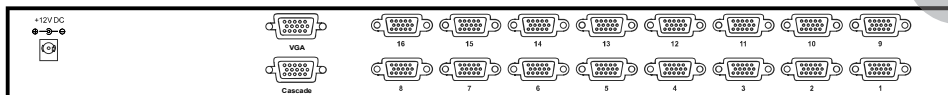

Designed and manufactured by Austin Hughes

Legal Information

First English printing, January 2023

Information in this document has been carefully checked for accuracy; however, no guarantee is given to the correctness of the contents. The information in this document is subject to change without notice. We are not liable for any injury or loss that results from the use of this equipment.

Safety Instructions

Please read all of these instructions carefully before you use the device. Save this manual for future reference.

- Unplug equipment before cleaning. Don't use liquid or spray detergent; use a moist cloth.
- Keep equipment away from excessive humidity and heat. Preferably, keep it in an air-conditioned environment with temperatures not exceeding 40° Celsius (104° Fahrenheit).
- When installing, place the equipment on a sturdy, level surface to prevent it from accidentally falling and causing damage to other equipment or injury to persons nearby.
- When the equipment is in an open position, do not cover, block or in any way obstruct the gap between it and the power supply. Proper air convection is necessary to keep it from overheating.
- Arrange the equipment's power cord in such a way that others won't trip or fall over it.
- If you are using a power cord that didn't ship with the equipment, ensure that it is rated for the voltage and current labeled on the equipment's electrical ratings label. The voltage rating on the cord should be higher than the one listed on the equipment's ratings label.
- Observe all precautions and warnings attached to the equipment.
- If you don't intend on using the equipment for a long time, disconnect it from the power outlet to prevent being damaged by transient over-voltage.
- Keep all liquids away from the equipment to minimize the risk of accidental spillage. Liquid spilled on to the power supply or on other hardware may cause damage, fire or electrical shock.
- Only qualified service personnel should open the chassis. Opening it yourself could damage the equipment and invalidate its warranty.
- If any part of the equipment becomes damaged or stops functioning, have it checked by qualified service personnel.

What the warranty does not cover

- Any product, on which the serial number has been defaced, modified or removed.
- Damage, deterioration or malfunction resulting from:
 - Accident, misuse, neglect, fire, water, lightning, or other acts of nature, unauthorized product modification, or failure to follow instructions supplied with the product.
 - Repair or attempted repair by anyone not authorized by us.
 - Any damage of the product due to shipment.
 - Removal or installation of the product.
 - Causes external to the product, such as electric power fluctuation or failure.
 - Use of supplies or parts not meeting our specifications.
 - Normal wear and tear.
 - Any other causes which does not relate to a product defect.
- Removal, installation, and set-up service charges.

Regulatory Notices Federal Communications Commission (FCC)

This equipment has been tested and found to comply with the limits for a Class B digital device, pursuant to Part 15 of the FCC rules. These limits are designed to provide reasonable protection against harmful interference in a residential installation.

Any changes or modifications made to this equipment may void the user's authority to operate this equipment. This equipment generates, uses, and can radiate radio frequency energy and, if not installed and used in accordance with the instructions, may cause harmful interference to radio communications.

However, there is no guarantee that interference will not occur in a particular installation. If this equipment does cause harmful interference to radio or television reception, which can be determined by turning the equipment off and on, the user is encouraged to try to correct the interference by one or more of the following measures:

- Re-position or relocate the receiving antenna.
- Increase the separation between the equipment and receiver.
- Connect the equipment into an outlet on a circuit different from that to which the receiver is connected.

Contents

< Part. 1 > Combo DB-15 KVM

-IP802	-IP1602
---------------	----------------

1.1	Package Contents	P.1
1.2	KVM port connection	P.2
1.3	IP console connection	P.3
1.4	Connect to IP console	P.4
1.5	IP Console Firmware Update	P.8
1.6	KVM Cascade	P.9
1.7	Specifications	P.10

< Part. 2 > Combo DB-15 2-console KVM

-802	-1602
-------------	--------------

2.1	KVM Cascade	P.11
2.2	KVM port connection	P.12
2.3	Remote console connection	P.13
2.4	KVM Cascade	P.15
2.5	Specifications	P.16

< Part. 3 > Combo DB-15 KVM

-S801	-S1601
--------------	---------------

3.1	Package Contents	P.17
3.2	KVM port connection	P.18
3.3	KVM Cascade	P.19
3.4	Specifications	P.20

< Part. 4 > Combo DB-15 KVM Usage

4.1	Password	P.21
4.2	KVM OSD	P.22
4.3	KVM Hotkey & Remote Console Hotkey	P.23
4.4	DC Power Option : 12V / 24V / 48V / 125V / 250V	P.24

-IP802
 -IP1602

KVM Rear Kit

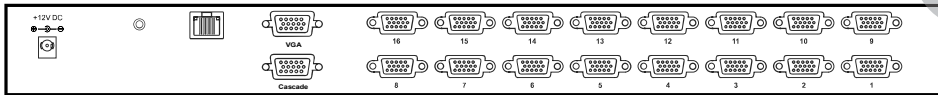

! The power of the KVM rear kit may be changed to external power design based on the LCD console drawer series and model.

-IP802

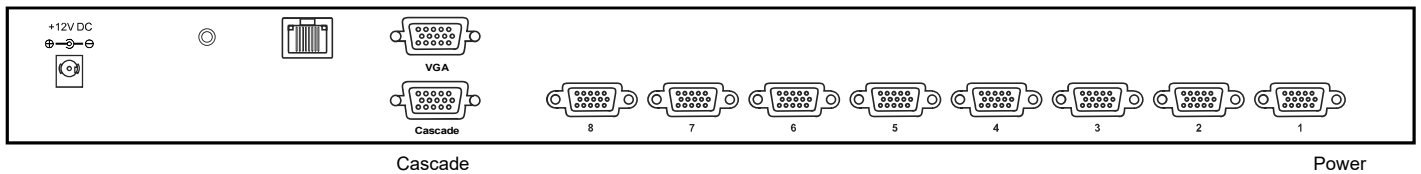

-IP1602

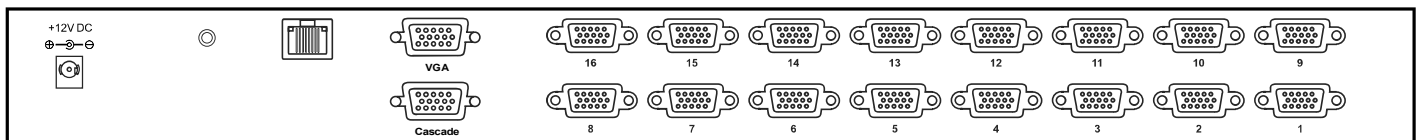

CB-6 / CB-10 / CB-15

- 6 / 10 / 15 ft USB KVM cable
- Support USB server



USB Servers

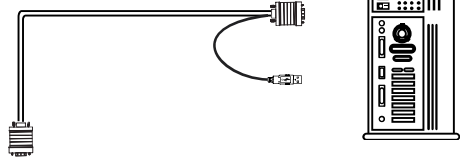

DB-15 Combo KVM port

Drawer KVM Rear Kit

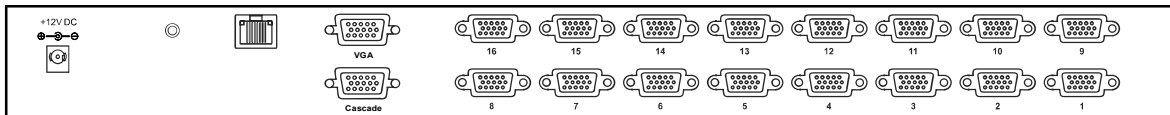

CB - 6 / 10 / 15 USB KVM cable support USB server

USB Servers



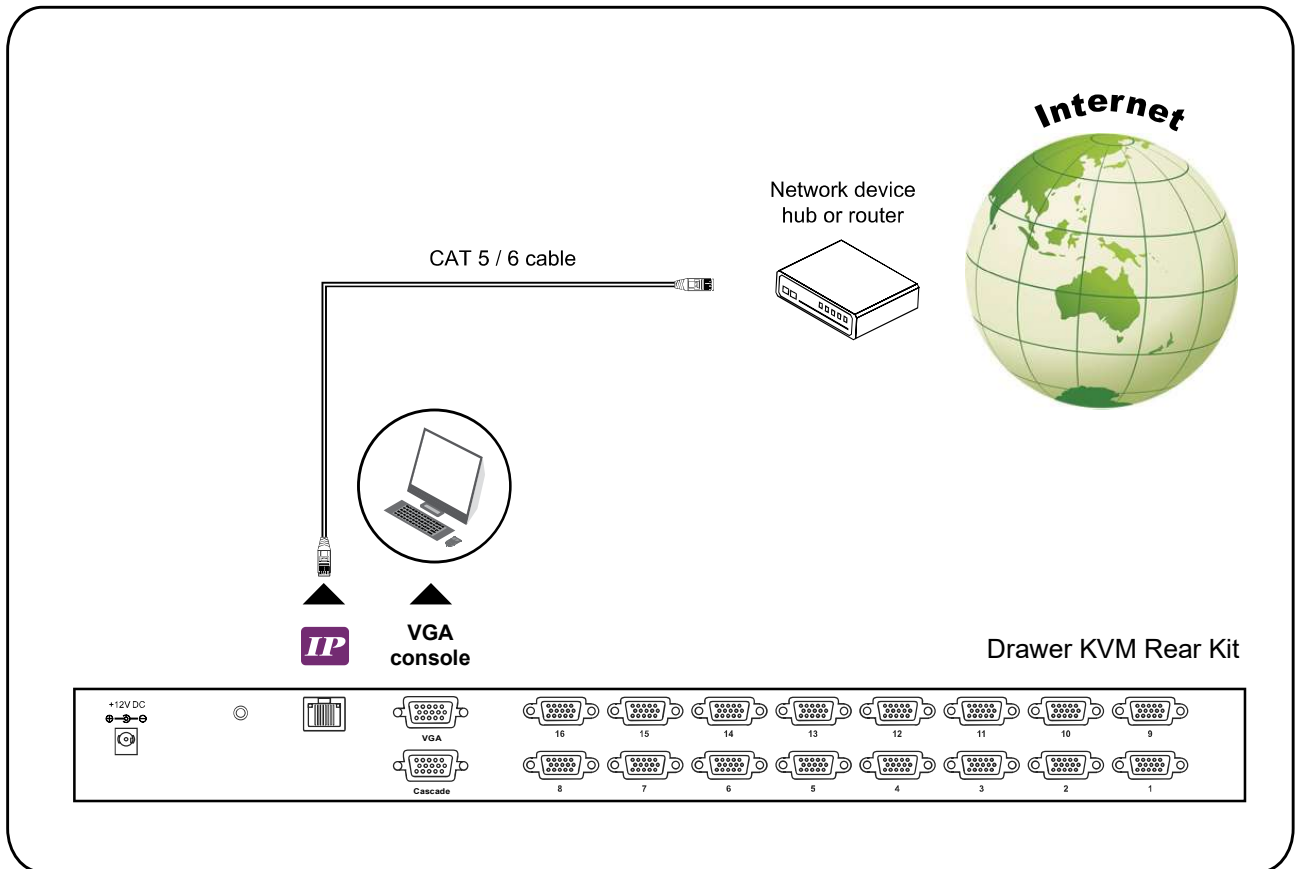

IP Console

Resolution Support	Frequency (Hz)
1920 x 1080	60
1920 x 1200	60
1600 x 1200	60
1280 x 1024	60
1024 x 768	60

 Please make sure to follow the below steps to setup your KVM IP properly.

I. Configure the target server

The target server is the server that connected to the IP KVM Switch. Before use IP remote access, you need to turn off mouse acceleration of all target servers. Please refer to below for Windows operating system.

Mouse setting

From the Control Panel, double-click the Mouse icon to open the Mouse Properties dialog box.

1. Move the pointer speed slider to the default of 50%.
(the middle of the slider or the sixth tick from the left).
2. Uncheck “*Enhance pointer precision*”.
3. Uncheck “*Automatically move pointer to the default button in a dialog box*” & “*Display pointer trails*”.
4. Windows enables mouse acceleration by default. Make sure you are logged in to windows to check mouse synchronization.
5. Mouse acceleration can only be turned off on a per Windows user basis. If you log in to Windows with a different user name, then you will have to configure mouse properties separately for that user as well.

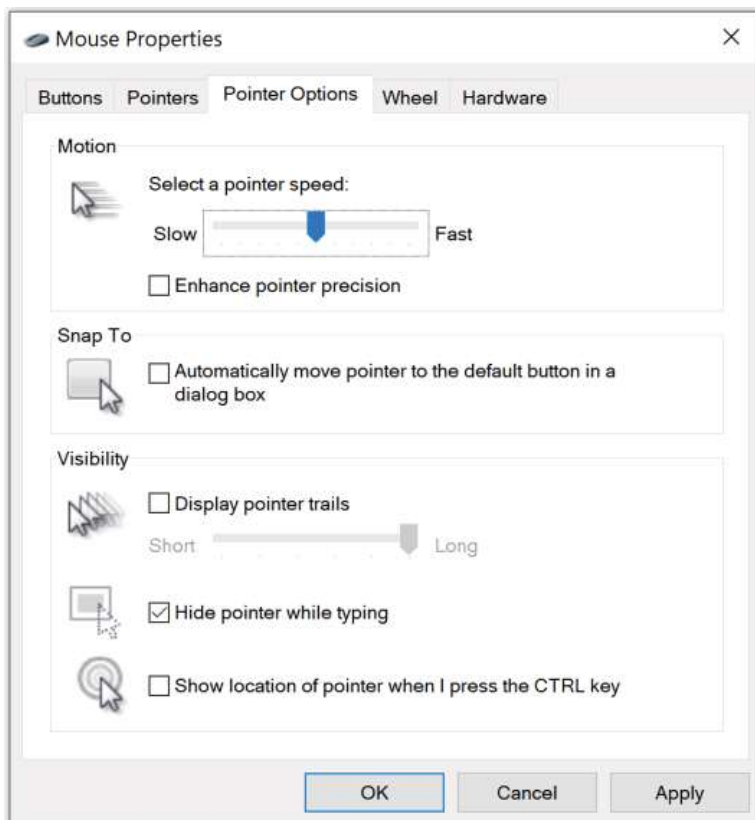

Change display scaling setting 100%

1. Open Settings.
2. Click on System.
3. Click on Display.
4. Under the “Scale and layout” section, select the scale 100%.

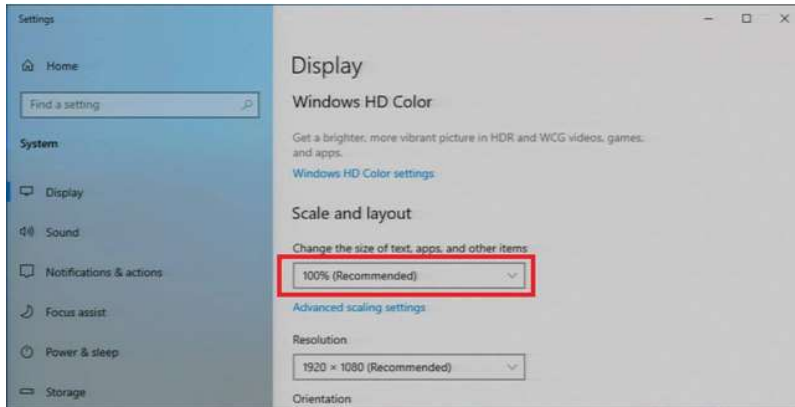

II. Logging in to IP KVM

The default IP address is as below:

IP address: 192.168.1.22

Subnet mask: 255.255.255.0

Gateway: 192.168.1.1

IP KVM model with single IP port:

- Default address 192.168.1.22

IP KVM model with dual IP ports:

- The 1st IP address 192.168.1.22

- The 2nd IP address 192.168.1.23

To log in to the IP KVM do as follows:

1. Open the browser on the client, in the address bar, enter the default IP KVM address (192.168.1.22)



2. In login dialog box, enter the user name and password, then click **Login**, the default user name is **super** and the default password is **pass**.
3. The IP KVM GUI is displayed, and the navigation bar is on left-side.

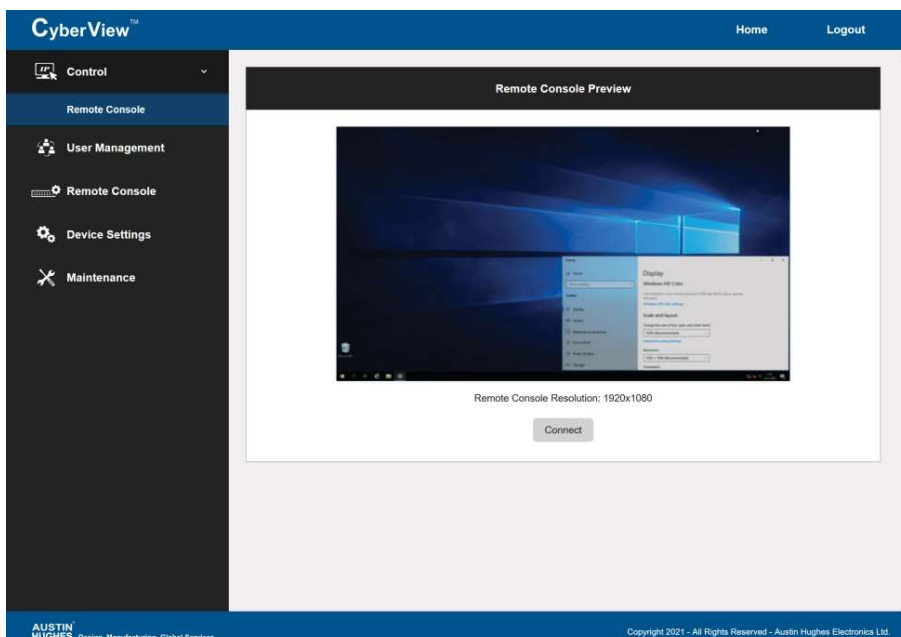

III. Configure Remote Console Resolution

The IP remote console displayed on the HTML5-based browser support multiple types of resolution, with a maximum of 1,920 x 1,200.

Click **Remote Console** and then **Resolution**, the Remote Console Video page is displayed, select the same resolution as target servers, click **Apply** to save the resolution.



The setting is enough for intranet.

If the users access KVM GUI via internet, please ask MIS for assistance and download IP KVM user manual from the link :

www.austin-hughes.com/support/usermanual/cyberview/UM-CV-IP.pdf

IV. Launch remote console

Click **Control** and then **Remote console**, the Remote console Preview is displayed, then Click **Connect**, the remote console opens in a separate windows.

When first start, the local mouse is not synchronized with the remote mouse, it appears at a distance to each other, press the **Mouse Sync** once (positioning top left corner), the mouse will align.

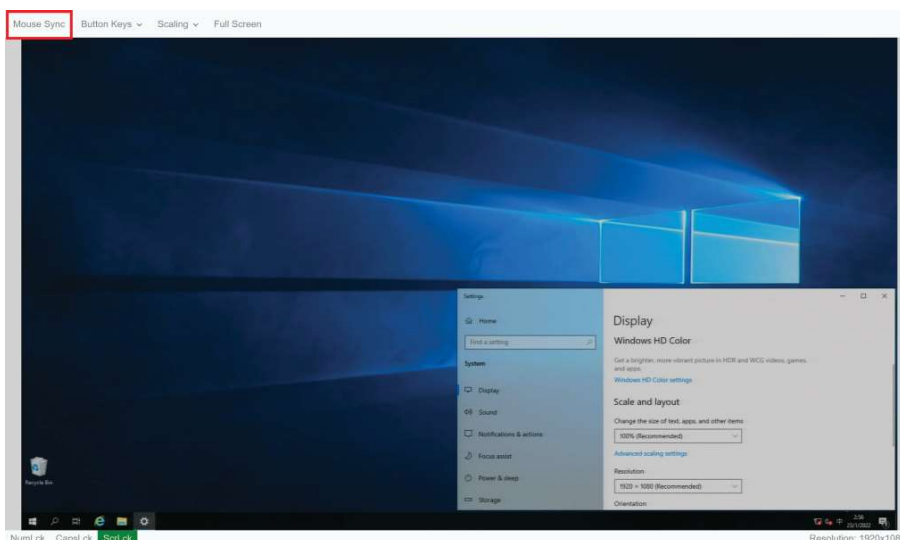

Firmware Update Steps

- 1) Download the latest IP KVM firmware from the link
<http://www.austin-hughes.com/resources/software/kvm-switch>
- 2) Login the IP KVM
- 3) Click < Maintenance >
- 4) Click < Update Firmware >
- 5) Click < Browse > to select the firmware file
- 6) Click < Update >

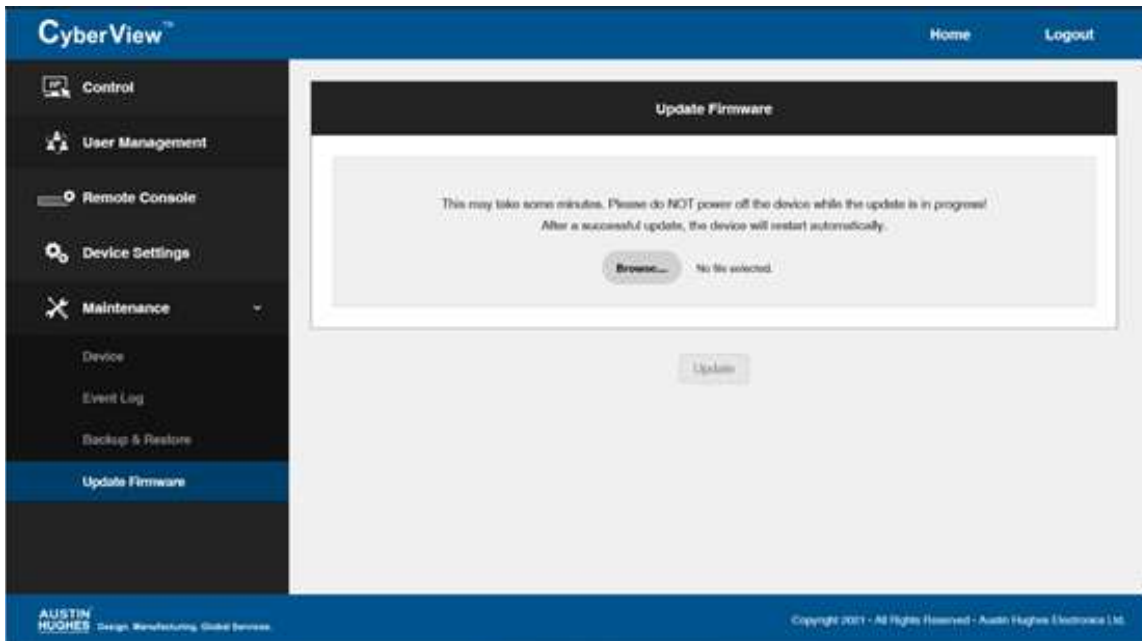

< 1.6 > KVM Cascade

Combo DB-15 IP KVM

- Cascade up to 8 levels, 128 servers
- Cascading multiple KVM with CBC-6 cascade cable.

! Cascaded KVMs from level 2 to 8 must be the models of CV-S801 / CV-S1601.

! When multiple combo DB-15 KVMs cascade together, the master KVM at level 1 will take all control of other Expansion KVM switches (e.g. level 2 to 8).

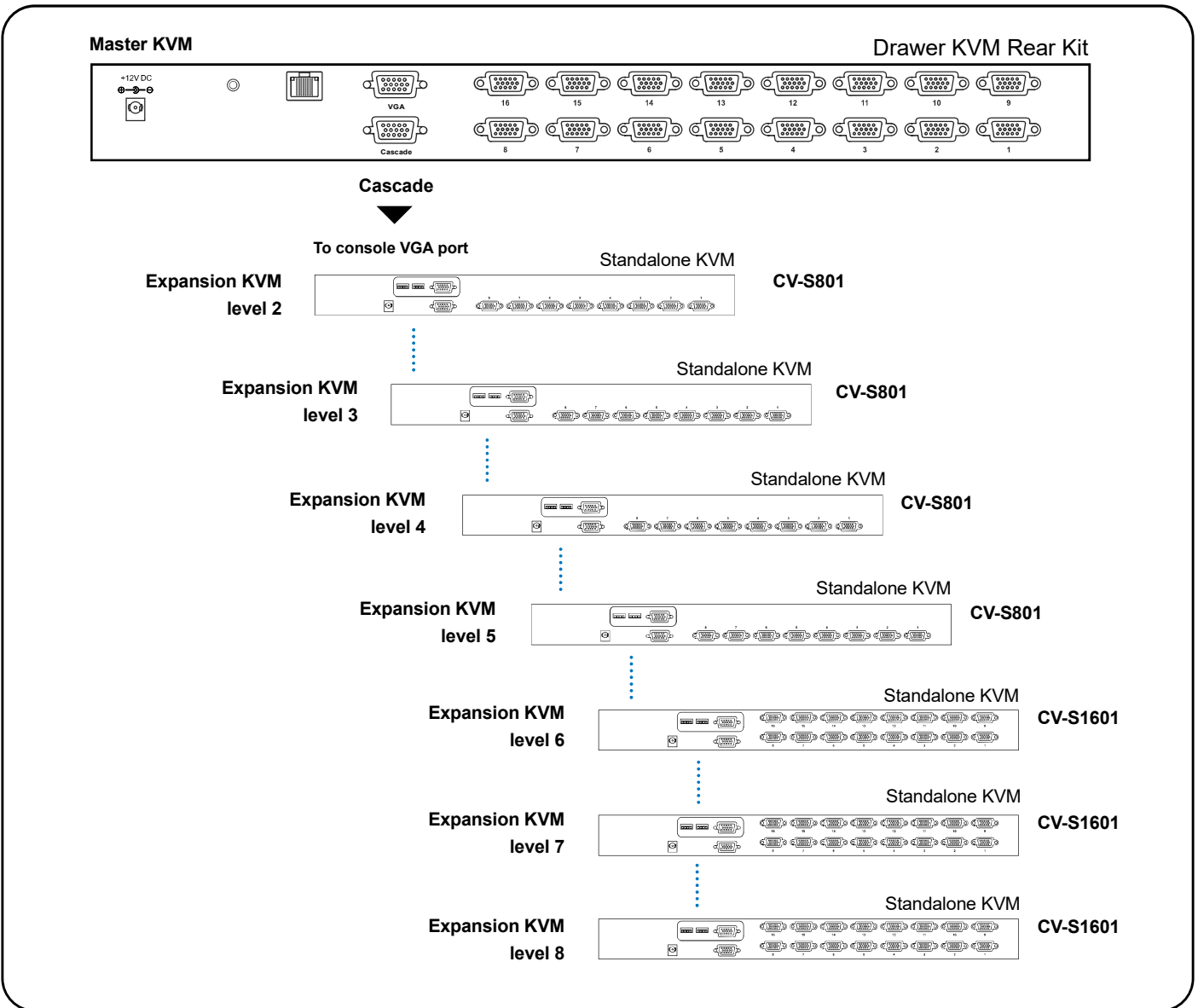

CBC-6

- 6ft Combo KVM cascade cable

-IP802		-IP1602
■ KVM Port		
Number of ports :	8 or 16	
Connector :	DB-15 combo connector	
Connectivity :	USB 2-in-1 KVM cable, up to 6, 10 & 15 feet	
■ Local Console : Nil for LCD console drawer version		
■ IP Remote Console		
Connector :	RJ45 Ethernet	
User management :	15-user login, 1 x active user	
Network protocol :	DHCP / BOOTP / DNS	
Security :	TLS 1.3, AES, LDAP, Active Directory (AD), HTTP(s)	
Browser :	Chrome, Firefox, Edge, etc.	
Resolution support :	16: 9 - max. 1920 x 1080 16:10 - max. 1920 x 1200 4: 3 - max. 1600 x 1200	
■ Expansion: Up to 128 servers by 8-level cascade		
■ Compatibility		
Hardware :	HP / IBM / Dell PC, Server and Blade Server SUN / Mac	
OS Support :	Windows / Linux / Unix / Mac OS	
■ Power		
Input :	Auto sensing 100 to 240VAC, 50 / 60 Hz	
Option DC :	12V / 24V / 48V / 125V DC input	
Consumption :	Max. 19W	
■ Compliance		
EMC :	FCC & CE	
Safety :	CE / LVD & UKCA	
Environment :	RoHS3 & REACH / WEEE	
■ Environmental	Operating	Storage / Non-operating
Temperature :	0 to 55°C degree	-20 to 60°C degree
Humidity :	10~90%, non-condensing	5~90%, non-condensing
Altitude :	16,000 ft	40,000 ft
Shock :	-	10G acceleration (11ms duration)
Vibration :	-	10~300Hz 0.5G RMS random vibration

-802 / -1602

- Receiver box for remote console x 1
- Power adapter w/ power cord (for receiver) x 1
- CB-6 6ft USB KVM cable for receiver box x 1

KVM Rear Kit

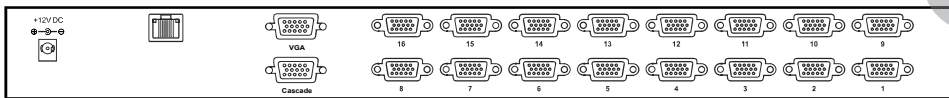

The power of the KVM rear kit may be changed to external power design based on the LCD console drawer series and model.

-802

Remote

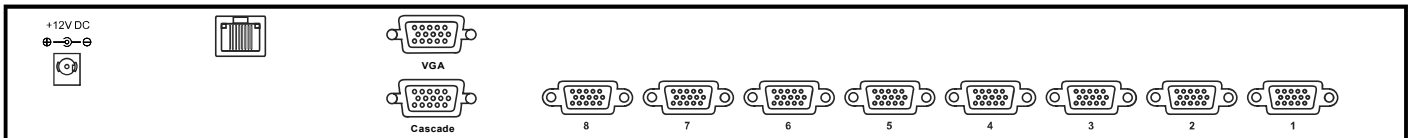

Power

Cascade

-1602

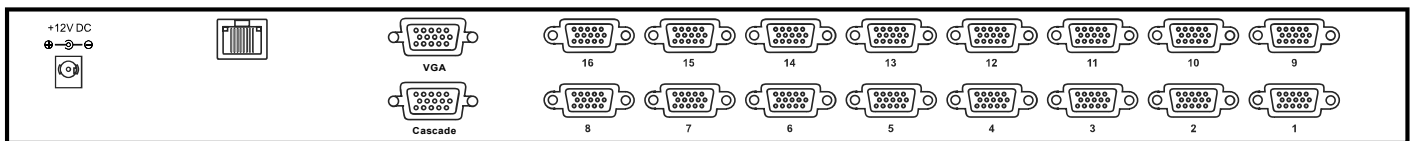

< 2.2 > KVM port connection

Combo DB-15 2-console KVM

CB-6 / CB-10 / CB-15

- 6 / 10 / 15 ft USB KVM cable
- Support USB server



USB Servers

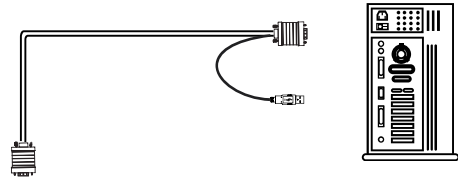

DB-15 Combo KVM port

Drawer KVM Rear Kit

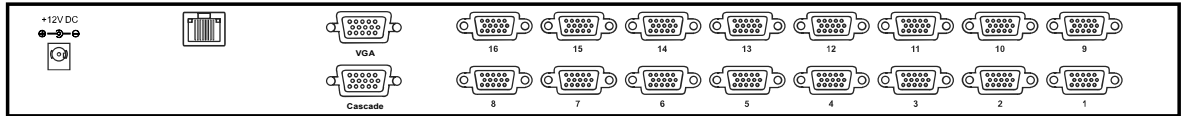

USB Servers

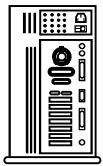

CB - 6 / 10 / 15 USB KVM cable
support USB server

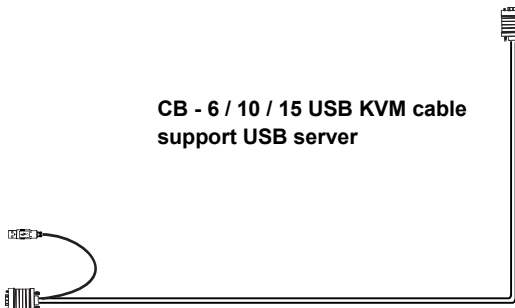

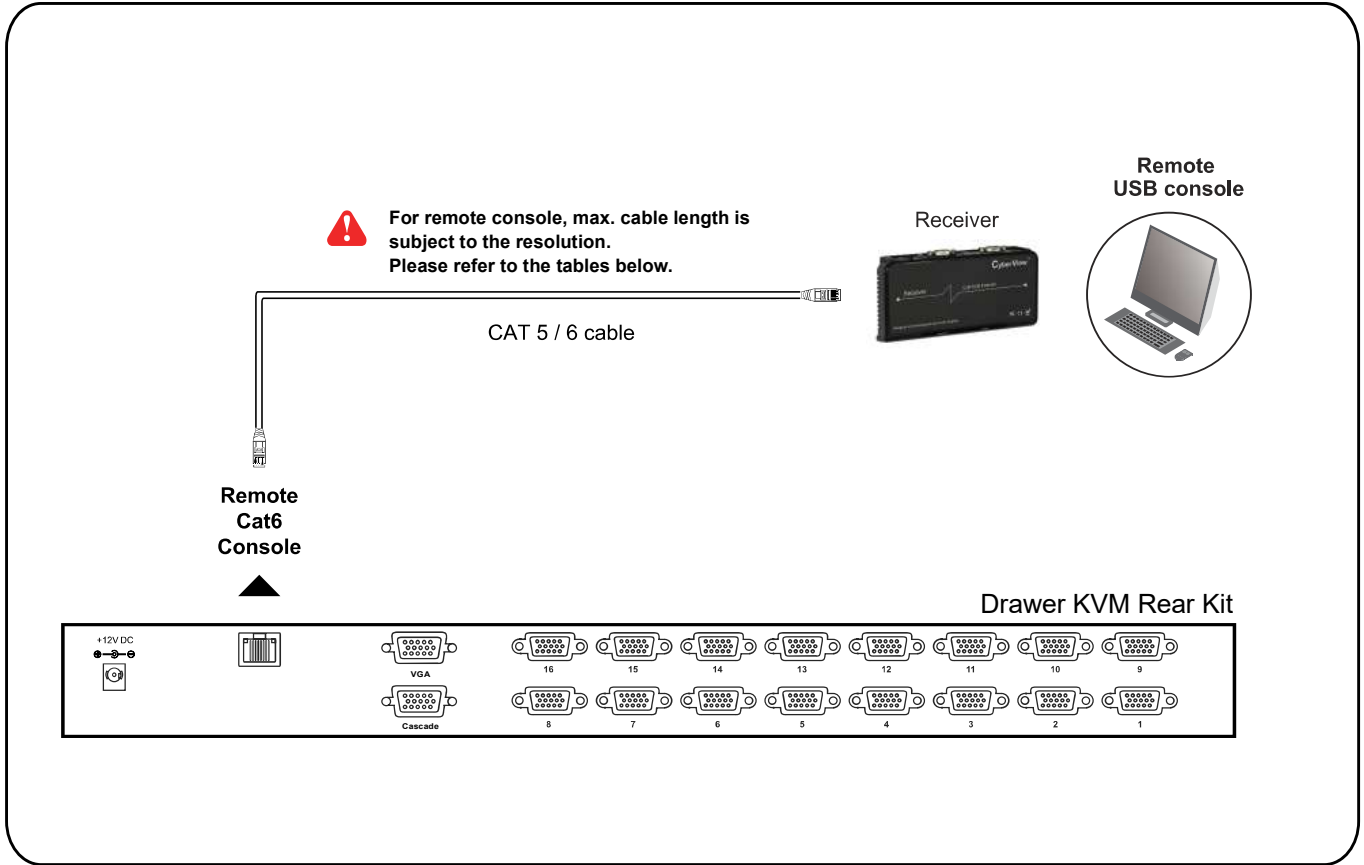

Remote Console

Resolution Support	Frequency (Hz)	Max. Cat6 Cable Length (M)
1920 x 1080	60	50
1920 x 1200	60	50
1600 x 1200	60	100
1440 x 900	60	100
1280 x 1024	60	150
1024 x 768	60 / 70 / 75	150

How to use a receiver to connect a remote console Combo DB-15 2-console KVM

Receiver

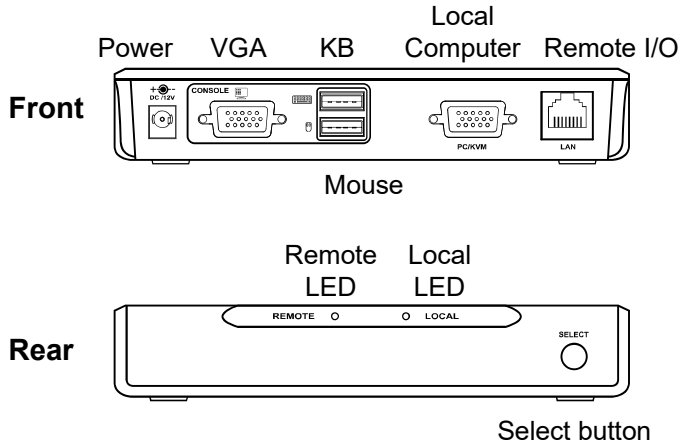

The receiver provides a hotkey function for remote console. Please refer to P.23

Remote Console Drawer KVM Rear Kit

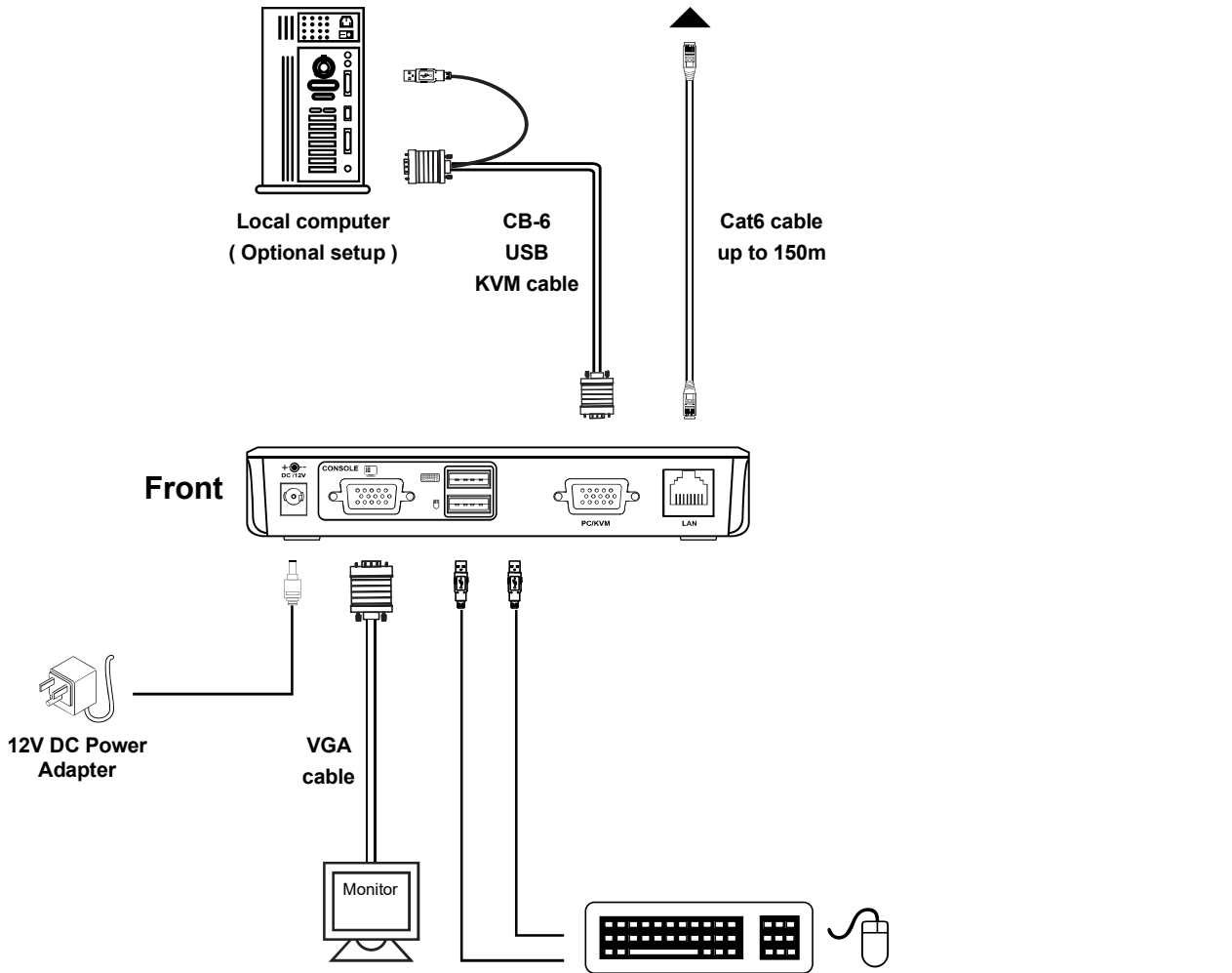
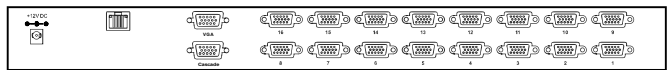

< 2.4 > KVM Cascade

Combo DB-15 2-console KVM

- Cascade up to 8 levels, 128 servers
- Cascading multiple KVM with CBC-6 cascade cable.

! Cascaded KVMs from level 2 to 8 must be the models of CV-S801 / CV-S1601.

! When multiple combo DB-15 KVMs cascade together, the master KVM at level 1 will take all control of other Expansion KVM switches (e.g. level 2 to 8).

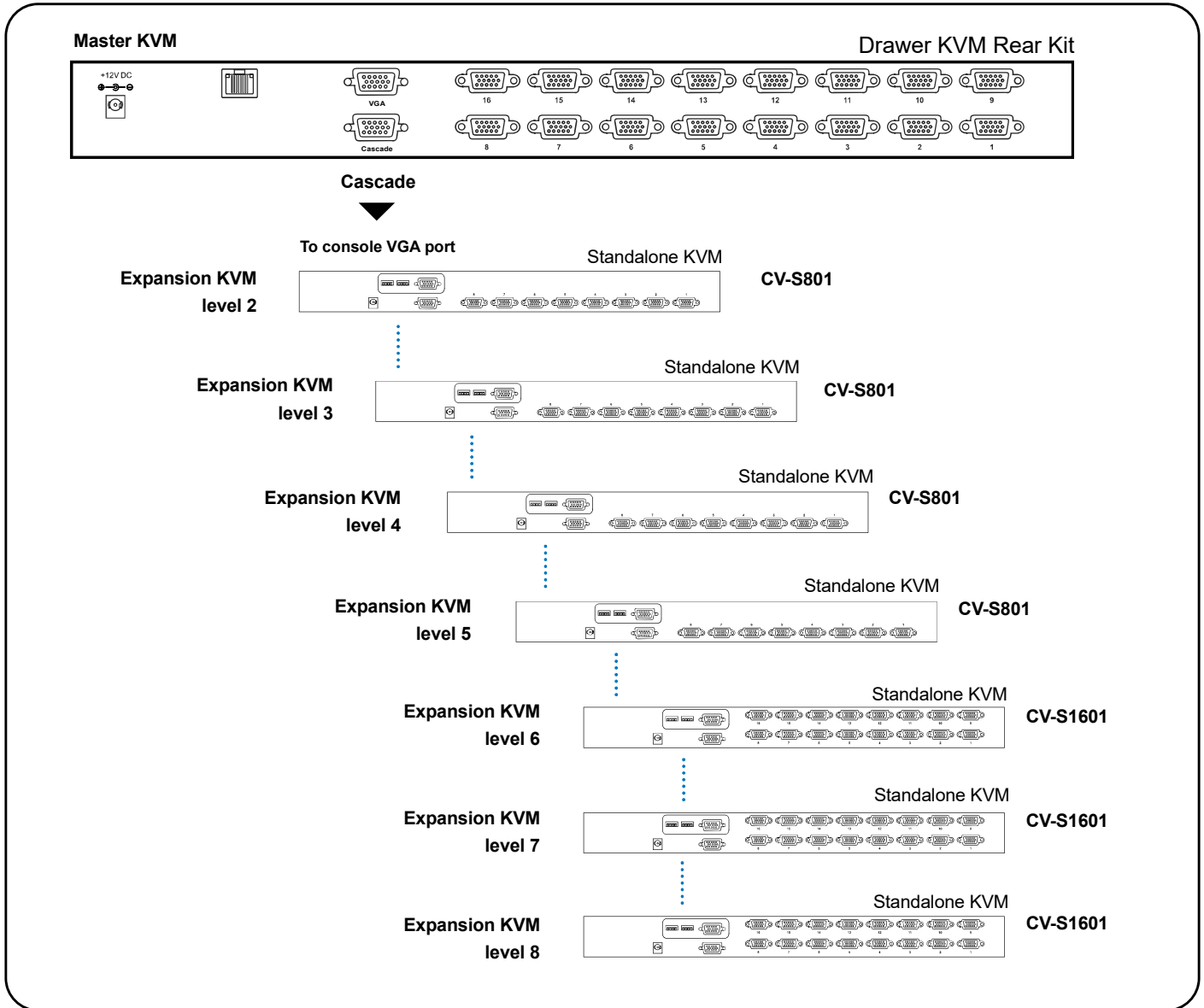

CBC-6

- 6ft Combo KVM cascade cable

-802		-1602
<p>■ KVM Port</p> <p>Number of ports : 8 or 16</p> <p>Connector : DB-15 combo connector</p> <p>Connectivity : USB 2-in-1 KVM cable, up to 6, 10 & 15 feet</p>		
<p>■ Local Console : Nil for LCD console drawer version</p>		
<p>■ Remote Console</p> <p>Connector : 1 x DB 15-pin, VGA</p> <p>Input device : 2 x USB type A for keyboard & mouse</p> <p>Remote I/O : RJ45 via Cat5 / Cat5e / Cat6 cable up to 150m</p> <p>Compensation : Auto adjust for cable length</p> <p>Resolution support : 16:9 - max. 1920 x 1080</p> <p style="padding-left: 150px;">16:10 - max. 1920 x 1200</p> <p style="padding-left: 150px;">4:3 - max. 1600 x 1200</p>		
<p>■ Expansion : Up to 128 servers by 8-level cascade</p>		
<p>■ Compatibility</p> <p>Hardware : HP / IBM / Dell PC, Server and Blade Server SUN / Mac</p> <p>OS Support : Windows / Linux / Unix / Mac OS</p>		
<p>■ Power</p> <p>Input : Auto sensing 100 to 240VAC, 50 / 60 Hz</p> <p>Option DC : 12V / 24V / 48V / 125V DC input</p> <p>Consumption : Max. 13W</p>		
<p>■ Compliance</p> <p>EMC : FCC & CE</p> <p>Safety : CE / LVD & UKCA</p> <p>Environment : RoHS3 & REACH / WEEE</p>		
<p>■ Environmental</p> <p>Temperature : 0 to 55°C degree</p> <p>Humidity : 10~90%, non-condensing</p> <p>Altitude : 16,000 ft</p> <p>Shock : -</p> <p>Vibration : -</p>		<p>Operating</p> <p>Storage / Non-operating</p> <p>-20 to 60°C degree</p> <p>5~90%, non-condensing</p> <p>40,000 ft</p> <p>10G acceleration (11ms duration)</p> <p>10~300Hz 0.5G RMS random vibration</p>

-S801
-S1601

KVM Rear Kit

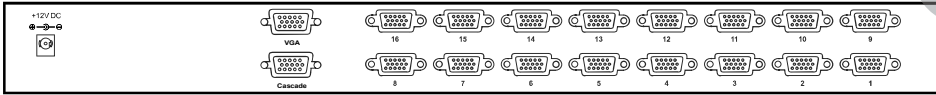

 The power of the KVM rear kit may be changed to external power design based on the LCD console drawer series and model.

-S801

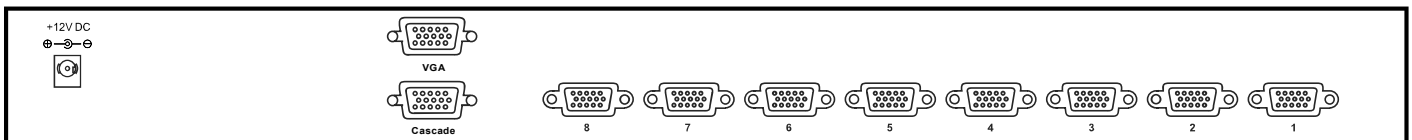

Power

Cascade

-S1601

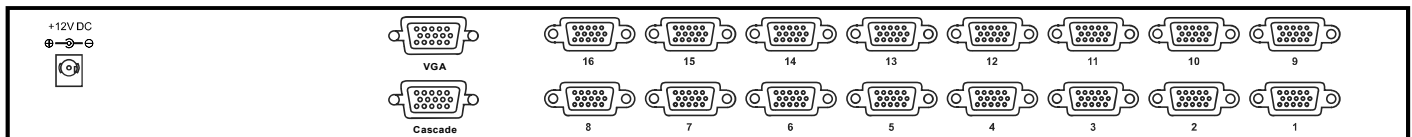

CB-6 / CB-10 / CB-15

- 6 / 10 / 15 ft USB KVM cable
- Support USB server



USB Servers

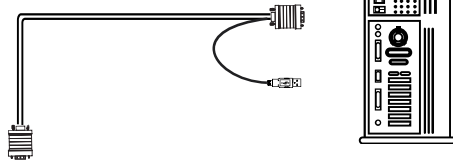

DB-15 Combo KVM port

Drawer KVM Rear Kit

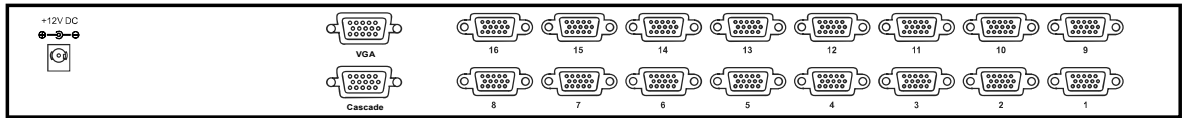

CB - 6 / 10 / 15 USB KVM cable support USB server

USB Servers

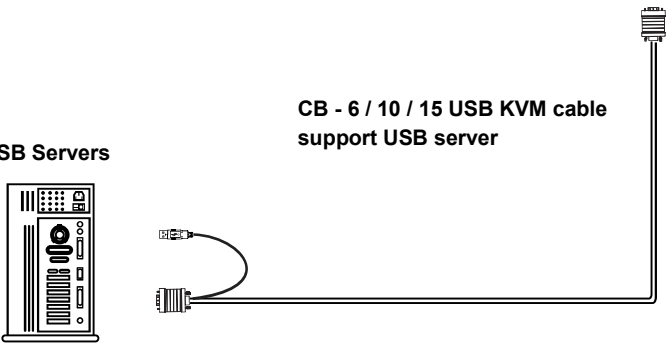

< 3.3 > KVM Cascade

Combo DB-15 KVM

- Cascade up to 8 levels, 128 servers
- Cascading multiple KVM with CBC-6 cascade cable.

! Cascaded KVMs from level 2 to 8 must be the models of CV-S801 / CV-S1601.

! When multiple combo DB-15 KVMs cascade together, the master KVM at level 1 will take all control of other Expansion KVM switches (e.g. level 2 to 8).

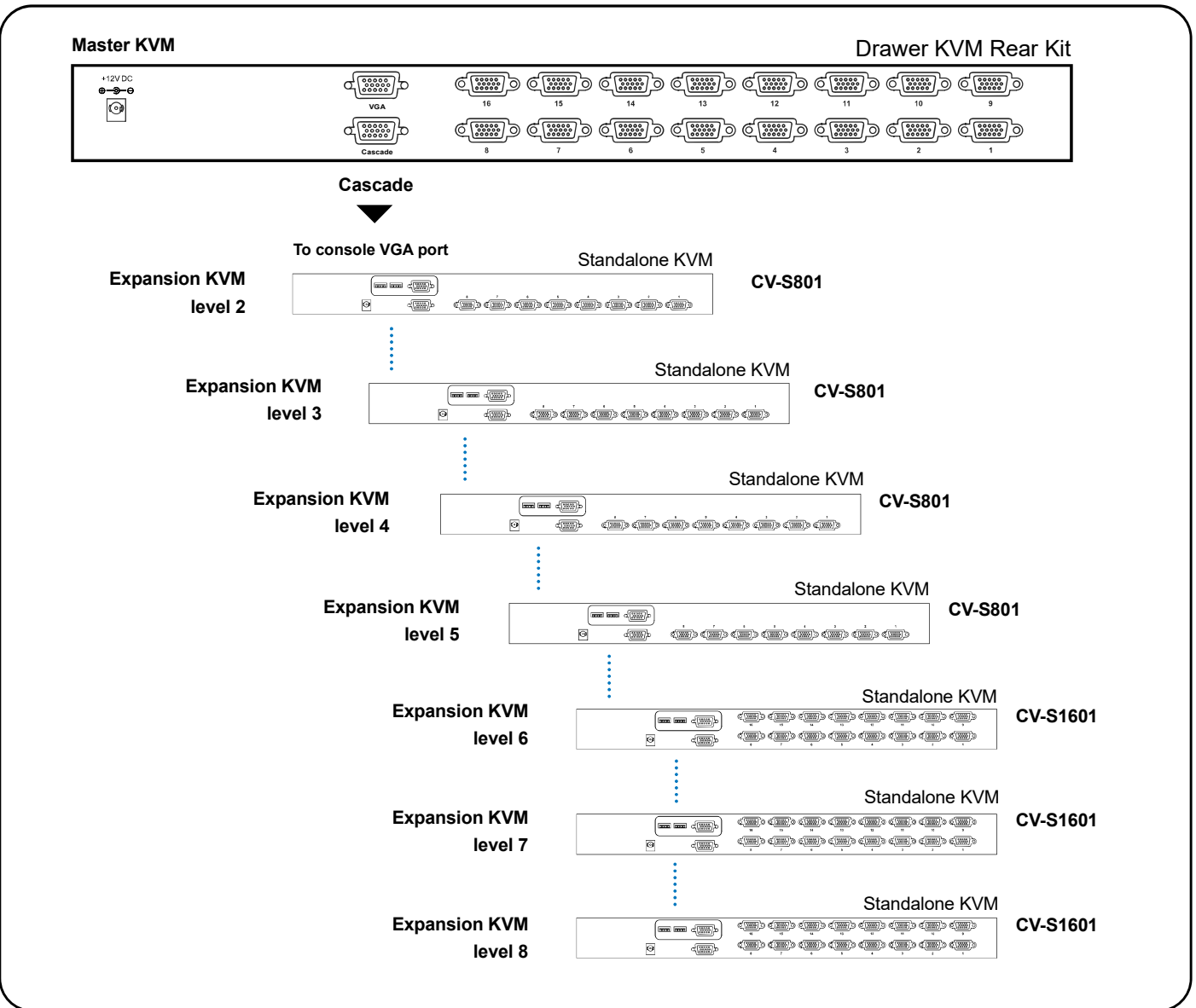

CBC-6

- 6ft Combo KVM cascade cable

-S801		-S1601
■ KVM Port		
Number of ports :	8 or 16	
Connector :	DB-15 combo connector	
Connectivity :	USB 2-in-1 KVM cable, up to 6, 10 & 15 feet	
■ Local Console : Nil for LCD console drawer version		
■ Management		
Multilingual OSD :	English, France, German, Spanish, Italian, Russian, Simplified Chinese, Japanese	
Hotkey combination :	Scroll-lock, Cap-lock, Num-lock, Alt, Ctrl & Win	
Security :	Password enable & disable, up to 8 users profile for port access	
PC Selection :	Front button, OSD menu & hotkey	
■ Expansion : Up to 128 servers by 8-level cascade		
■ Compatibility		
Hardware :	HP / IBM / Dell PC, Server and Blade Server SUN / Mac	
OS Support :	Windows / Linux / Unix / Mac OS	
■ Power		
Input :	Auto sensing 100 to 240VAC, 50 / 60 Hz	
Option DC :	12V / 24V / 48V / 125V DC input	
Consumption :	Max. 11W	
■ Compliance		
EMC :	FCC & CE	
Safety :	CE / LVD & UKCA	
Environment :	RoHS3 & REACH / WEEE	
■ Environmental	Operating	Storage / Non-operating
Temperature :	0 to 55°C degree	-20 to 60°C degree
Humidity :	10~90%, non-condensing	5~90%, non-condensing
Altitude :	16,000 ft	40,000 ft
Shock :	-	10G acceleration (11ms duration)
Vibration :	-	10~300Hz 0.5G RMS random vibration

The password is enabled by default, the default password is “00000000” eight zeros (**Do not use “0” on number pad**)

■ Enable password

1. Press the KVM hotkey **Scroll Lock + Scroll Lock + U**
2. Logout the KVM by pressing the hotkey **Scroll Lock + Scroll Lock + P**
3. In SUPERVISOR level, enter “00000000” eight zeros in user name & password field (**Do not use “0” on number pad**)
4. In USER level, press **Space bar + Enter** in user name & password field

Remark: Automatic logout after 10 minutes of inactivity

■ Set your own user name & password

1. Login the KVM in SUPERVISOR level by pressing “00000000” eight zeros in user name & password field
2. Call KVM OSD menu by pressing the KVM hotkey **Scroll Lock + Scroll Lock + Space Bar**
3. Press **F1** to the MAIN MENU
4. Select “USER SECURITY”
5. Set password in SUPERVISOR & USER level
 - a. In the left-top row “S” (SUPERVISOR), press **Enter** to set your own user name & password
 - b. In the row 1 to 8 (USER), press **Enter** to set your own user name & password
6. Press **Enter** to save the setting or press **Esc** to cancel the editing without any change

Remark: a. Blank has underscore, while SPACE doesn't have

- b. Press any alphanumeric key to move to next input item. SPACE is treated as a valid character

■ Change your password

1. Login the KVM in SUPERVISOR level by pressing your own user name & password
2. Call KVM OSD menu by pressing the KVM hotkey **Scroll Lock + Scroll Lock + Space Bar**
3. Press **F1** to the MAIN MENU
4. Select “USER SECURITY”
5. Change password in SUPERVISOR & USER level
 - a. In the left-top row “S” (SUPERVISOR), press **Enter** to change your user name & password
 - b. In the row 1 to 8 (USER), press **Enter** to change your user name & password
6. Press **Enter** to save the setting or press **Esc** to cancel the editing without any change

Remark: a. Blank has underscore, while SPACE doesn't have

- b. Press any alphanumeric key to move to next input item. SPACE is treated as a valid character

■ Disable your password

1. Press the KVM hotkey **Scroll Lock + Scroll Lock + U**
2. Logout the KVM by pressing the KVM hotkey **Scroll Lock + Scroll Lock + P**
3. You don't need user name & password to access the KVM OSD menu

■ Forget your password

Please contact your supplier for further support



Remark:

- You must press the KVM hotkey within 2 seconds
- A beep sound will be heard for successful entering KVM hotkey

OSD Menu

PORT NAME	
BANK : 1	
01☼ SYSTEM 01	F1 : MENU
02☼ SYSTEM 02	F2 : LOGOUT
03☼ SYSTEM 03	F3 : PREV
04☼ SYSTEM 04	ESC : QUIT
05☼ SYSTEM 05	ENTER : COMPLETE
06☼ SYSTEM 06	↑/↓ : SELECT
07☼ SYSTEM 07	PgUp/PgDn : BANK SELECT
08☼ SYSTEM 08	
USER : SUPERVISOR	
SCAN TIME : 10 SEC	
FW1V3	

OSD operation

 next to the system name	The PC is powered on
 next to the system name	The PC is selected
F1	Access F1 MAIN MENU
F2	Logout the OSD menu
F3	Previous menu
Esc	Cancel / Quit
Enter	Complete / Switch to selected port
↑/↓	Switch to previous or next port
PgUp/PgDn	Switch to previous bank or next bank
1 / 2 / 3 / 4	Display port 01 ~ 08 / 09 ~ 16 / 17 ~ 24 / 25 ~ 32 Remark: Display port 17 ~ 32 for 32 port model only

F1 Main Menu

MAIN MENU	
SELECT OPTION :	
01 LANGUAGE	
02 PORT NAME EDIT	
03 PORT SEARCH	
04 USER SECURITY	
05 ACCESS LIST	
06 HOTKEY	
07 TIME SETTINGS	
08 OSD MOUSE	

01 LANGUAGE	OSD language change
02 PORT NAME EDIT	Define port name
03 PORT SEARCH	Quick searching by port name
04 USER SECURITY	Change password
05 ACCESS LIST	Define user access authority
06 HOTKEY	Change hotkey
07 TIME SETTINGS	Modify scan display time interval
08 OSD MOUSE	Modify OSD mouse speed

Local / IP Remote Console Hotkey	Function
Scroll Lock + Scroll Lock + Space Bar	Calling OSD menu
Right-button mouse + Esc	Calling OSD menu
Scroll Lock + Scroll Lock + ↑	Switch to previous port
Scroll Lock + Scroll Lock + ↓	Switch to next port
Scroll Lock + Scroll Lock + PgUp / PgDn	Switch to previous bank or next bank
Scroll Lock + Scroll Lock + Bank no. + Port no.	Switch to specific port
Scroll Lock + Scroll Lock + B	Turn the buzzer ON and OFF * Default the buzzer is ON
Scroll Lock + Scroll Lock + P	Logout the KVM if password security is ON. Show up the status windows

Advance hotkeys (for Supervisor login only)

Scroll Lock + Scroll Lock + S	Activate auto-scan mode for connected servers *Press any key to exit the auto-scan mode
Scroll Lock + Scroll Lock + R	Reset all the KVM settings to factory default *Except User Security settings
Scroll Lock + Scroll Lock + U	Disable and enable password security *Default security is ON
Scroll Lock + Scroll Lock + L	To enable / disable the screen saving function and 10 minutes auto-logout *Default the screen saving is OFF

Remarks:

- Example of “**Scroll Lock + Scroll Lock + Bank no. + Port no.**”
 - Bank No. : 1 to 8
 - Port No. : 01 to 16
 - e.g. Bank 1 Port 4 : **Scroll Lock + Scroll Lock + 1 + 0 + 4**
 - e.g. Bank 2 Port 16 : **Scroll Lock + Scroll Lock + 2 + 1 + 6**
- You must press the hotkey within 2 seconds
- A beep sound will be heard for successful entering
- The numeric keypad is not supported, while in OSD screen, the arrow keys, PgUp, PgDn, and Enter keys are supports

Cat6 Remote Console Hotkey

Cat6 Remote Console Hotkey	Function
Scroll Lock + Scroll Lock + C	Toggle switch between remote & local port
Scroll Lock + Scroll Lock + Q	Turn the buzzer ON & OFF *Default the buzzer is ON
Scroll Lock + Scroll Lock + S	Activate auto-scan mode for remote & local port *The scan time interval is 5 seconds
Scroll Lock + Scroll Lock + A	Auto-adjust the video signal

< 4.4 > Options : DC Power

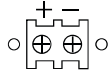

Combo DB-15 KVM

Model	12V	24V	48V	125V	250V
Input rating					
Input voltage:	12-Volt	24-Volt	48-Volt	110-Volt	300-Volt
Input range:	9 ~ 18V	18 ~ 36V	36 ~ 75V	66 ~ 160V	180 ~ 425V
Input current					
- No load	50 mA	50 mA	50 mA	35 mA	10 mA
- Full load	4950 mA	2450 mA	1220 mA	749 mA	600 mA
Output rating					
Output voltage:	12-Volt	12-Volt	12-Volt	12-Volt	12-Volt
Output current:	4.16A	4.16A	4.16A	6.25A	12.5A
Efficiency	84%	85%	85%	91%	86%

*** For DC power option :

(1) If the unit with LCD, earthing may be required 

(2) DC power excludes AC power cord.

The company reserves the right to modify product specifications without prior notice and assumes no responsibility for any error which may appear in this publication.

All brand names, logo and registered trademarks are properties of their respective owners.

Copyright 2023 Austin Hughes Electronics Ltd. All rights reserved.